

Interaction of Intermodulation Products between DUT and Spectrum Analyzer

White Paper

Products:

- | R&S®FSQ
- | R&S®FSW

This white paper describes the interaction between intermodulation products generated by a device under test (DUT) and intermodulation products generated internally in a spectrum analyzer. The overall intermodulation distortion may be too optimistic or pessimistic. Examples demonstrating cancelling IM products and necessary steps to avoid an influence of the spectrum analyzer on the measurement results are outlined.

Table of Contents

1	Intermodulation Distortion	3
1.1	Dynamic Range.....	4
1.2	Two-Tone Example.....	7
1.3	OFDM Example	10
2	Estimating IM distortion	11
3	Conclusion.....	14
4	Literature.....	15
5	Ordering Information	15

1 Intermodulation Distortion

IM products of 3rd order due to nonlinearities in a device like a power amplifier are major contributors to performance degradation of a communication system. This is true for in-band intermodulation e.g. with multi-carrier OFDM systems where the transmit signal is degraded, as well as for out of band intermodulation where the adjacent channels are affected. In-band IM distortion leads to a degraded signal quality in terms of e.g. modulation accuracy measured by EVM. In a transmitter the output amplifier is most often responsible for the intermodulation performance as it has to handle the highest power in the transmit signal path. However, also active devices in front of the power amplifier can contribute to the IM performance if not carefully designed. If two active devices in a signal path generate intermodulation products with approximately the same amplitudes, the resulting IM is dependent on the phase relationship of the individual IM products. This can be seen best in case of a two-tone intermodulation where two sine wave signals are applied to the DUT and the 3rd order IM products are considered. Dependent on the phase relationship between the IM products of both devices, the amplitude of the resulting IM product may be added up leading to an increased IM distortion or subtracted leading to a cancellation of IM distortion. Figure 1 shows an example with two sinusoid signals representing intermodulation products.

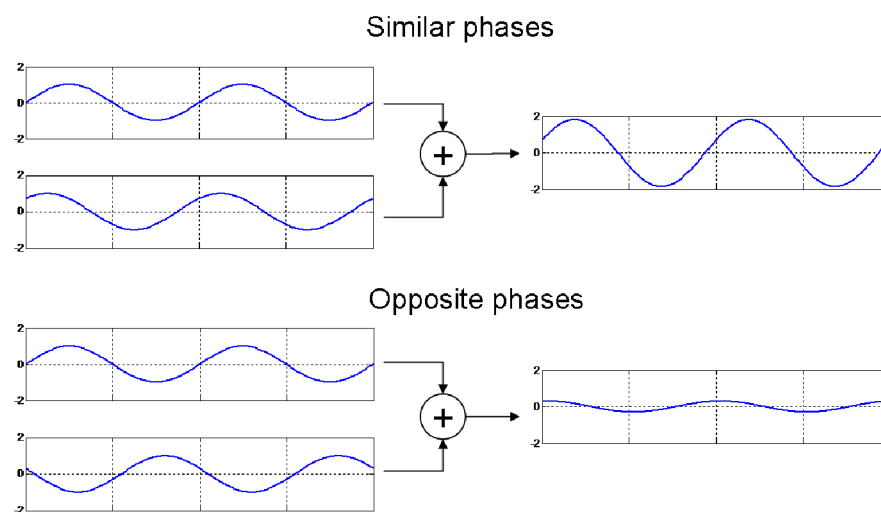

Figure 1: Constructive and destructive interference of two sinusoids

The phenomenon of IM cancellation (opposite phase IM products) is well known and used on purpose in amplifier pre-distortion techniques, where a nonlinear module placed between input signal and amplifier inserts IM distortion similar to the amplifier generated distortion but of opposite phase. At the output of the amplifier these IM products are cancelled and the linearity of the overall system improves.

When measuring intermodulation products with a spectrum analyzer a similar situation as with cascaded active devices can occur. As a spectrum analyzer also includes non-linear devices like the input mixer or a pre-amplifier, it generates its own intermodulation products, which might have a similar amplitude as the IM products generated by the DUT. Depending on the phase relationship between the IM products of the DUT and spectrum analyzer, the overall IM distortion can be higher (in-phase IM products) or lower (opposite phase IM products) than the DUT's actual IM distortion. Both cases lead to unwanted distortions of measurements done with a spectrum analyzer and must thus be avoided.

Spectrum analyzers provide mechanical step attenuators following the RF input connectors to adjust the level at the input of potentially non-linear devices like the pre-amplifier or the first mixer (see Figure 2). By adjusting the level at the first mixer appropriately IM distortion can be avoided. Some spectrum analyzers additionally use electronic attenuators e.g. for switching speed. However, these attenuators are designed in a way that they do not contribute to the overall nonlinearities in the spectrum analyzers signal path. Basically all semiconductor components following the step-attenuator can contribute to IM distortion, whereas the main contributor normally is the input mixer, even if a pre-amplifier is used. In this case the input mixer is loaded by a level increased by the pre-amplifier gain.

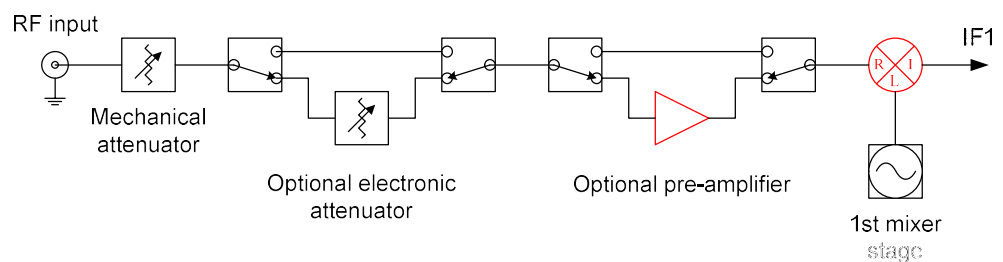

Figure 2: Typical RF frontend of a spectrum analyzer. Components highlighted in red can generate IM products.

1.1 Dynamic Range

For a given power level of a signal to be measured several factors limit the dynamic range of a spectrum analyzer. These factors are also dependent on the character of the signal:

- The inherent noise floor P_N of the spectrum analyzer for lower power levels
- The compression of the input mixer for high power levels
- The phase noise for small signals close to a high level carrier

When multiple tones are applied to the spectrum analyzer, IM products may limit the dynamic range. Especially the 3rd order intermodulation has to be considered as it results in the highest IM products. Spectrum analyzer data sheets provide a specification for two-tone IM distortion either as an intermodulation free dynamic range at a specified level of two CW carriers with a given frequency offset or by the so called *Third Order Intercept* point (T.O.I.) also measured with a two-carrier CW signal with a given frequency offset.

The T.O.I. is the theoretical power level which would generate 3rd order IM products having the same level as the applied CW signals. The T.O.I. can be calculated as

$$TOI = P_{in} + P_{\Delta} / 2 \quad (1)$$

where TOI is the Third Order Intercept point in dBm, P_{in} is the level of each tone of the two-tone input signal in dBm and P_{Δ} is the amplitude of the IM products relative to P_{in} . Figure 3 shows a schematic representation of these values.

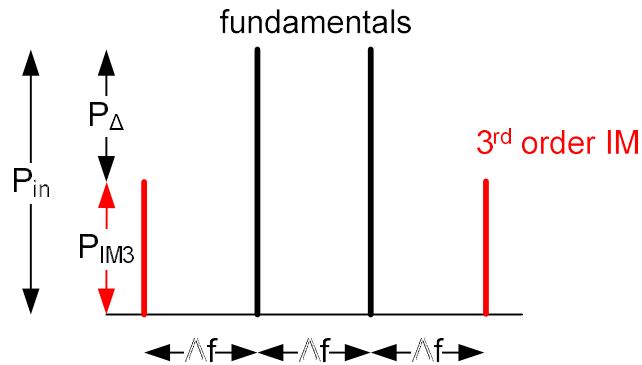

Figure 3: Schematic diagram of 3rd order IM components and relevant parameters.

Due to compression in active devices the T.O.I. level cannot be reached in a real measurement (e.g. at an output of an amplifier). However, it is a good figure of merit to calculate the intermodulation free dynamic range P_{Δ} at a given level of a two-tone signal according to

$$P_{\Delta} = 2(TOI - P_{in}) \quad (2)$$

The amplitude P_{IM3} of the 3rd order IM products is accordingly

$$\begin{aligned} P_{IM3} &= P_{in} - P_{\Delta} \\ &= P_{in} - 2(TOI - P_{in}) \\ &= 3P_{in} - 2TOI \end{aligned} \quad (3)$$

Another factor limiting dynamic range, especially for low input powers, is the spectrum analyzer's noise floor. In the data sheets this is specified as the *Displayed Average Noise Floor* (DANL).

Putting all distortions together yields the so called *dynamic range chart* shown in Figure 4. For low input powers the noise floor is limiting the dynamic range whereas for higher levels it is the 3rd order IM distortion. 2nd order IM distortions and phase noise also influence the dynamic range. 2nd order IM is not considered further since the distortion products fall at frequencies far from the signal ($f_1 + f_2$ and $f_2 - f_1$) and are thus not relevant for in-band distortion and ACLR. Summing up all distortion sources in the linear domain gives the actual dynamic range for a spectrum analyzer. The minimum of this curve is called the *optimum mixer level*. At this point the spectrum analyzer achieves the maximum dynamic range. By using the preamplifier and step attenuator the mixer level for a given input signal can be set to this optimal value.

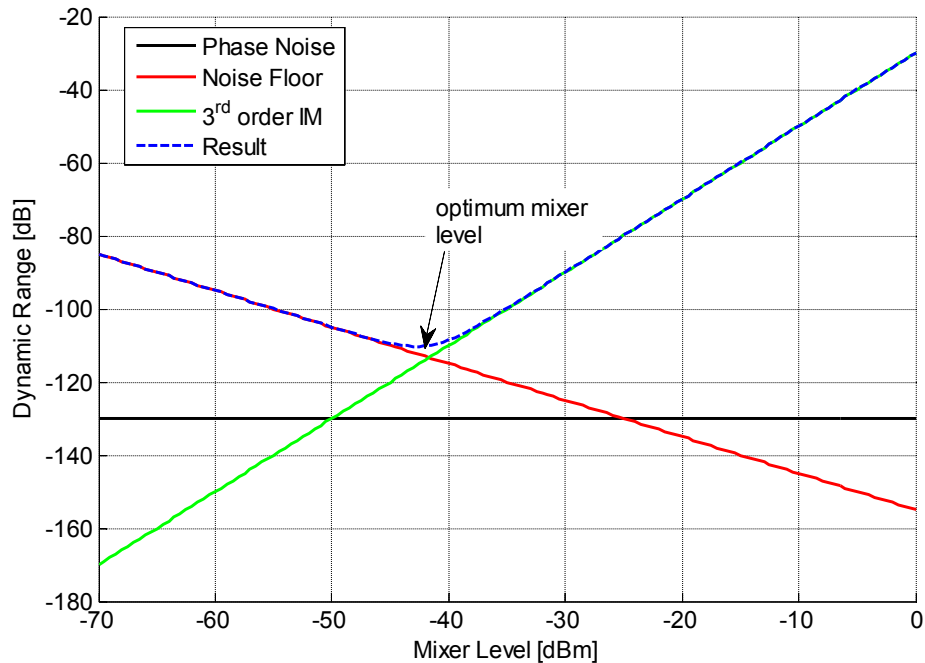

Figure 4: Dynamic Range Chart. $TOI = 15\text{dBm}$, $DANL = -155\text{dBm/Hz}$, $\text{Phase Noise} = -130\text{dBc}$.

The 3rd order IM curve has a slope of +2, so for a 1dB rise in mixer level a 2dB increase in 3rd order IM products results, leading to a 2dB decrease in dynamic range. On the other hand with every 1dB mixer level increase, the noise floor decreases by 1dB.

For real measurements, and particularly for wideband signals, the increase in noise floor due to a wide signal bandwidth needs to be taken into account. When talking about the analyzers first mixer filter settings are not of importance since the mixer always sees the full bandwidth and so only the signal bandwidth is relevant. The bandwidth dependent noise floor relative to the mixer level is given as

$$P_N = [DANL + B - P_{in}] \text{dB} \quad (4)$$

with B as the bandwidth of the signal in dB. As a result the dynamic range decreases and the optimum mixer level shifts to the right. Figure 5 shows an example with $B=100\text{kHz}$ (50dB).

A thorough treatment of these topics can be found in [1]. A spread sheet accompanying the text book helps to draw the dynamic range chart based on an analyzers' data sheet parameters.

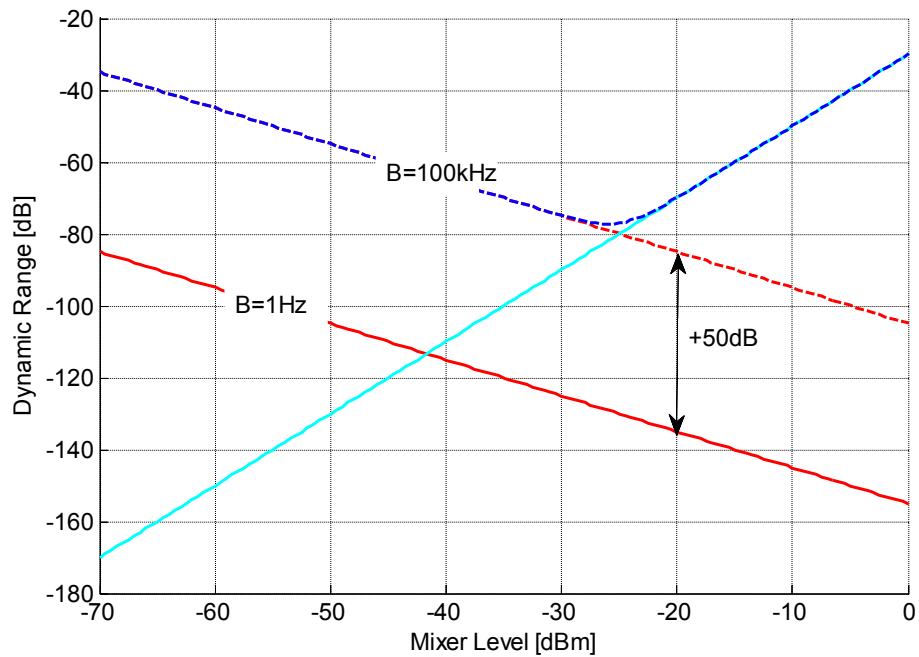

Figure 5: Noise floor increase due to a wideband signal.

1.2 Two-Tone Example

We use a classical two-tone measurement to demonstrate the interaction of the IM products of a DUT and spectrum analyzer. Here CW signals of two generators are combined and fed into the DUT and the resulting 3rd order IM products are measured by a spectrum analyzer. This is a typical measurement for characterizing the amount of IM distortion of a device. Two tones at frequencies f_1 and f_2 of equal amplitude and uncorrelated phase, separated Δf apart, will produce 3rd order IM products at $f_1 - \Delta f$ and $f_2 + \Delta f$. P_{Δ} is used to characterize the amount of IM distortion. Figure 6 shows a block diagram of the measurement setup.

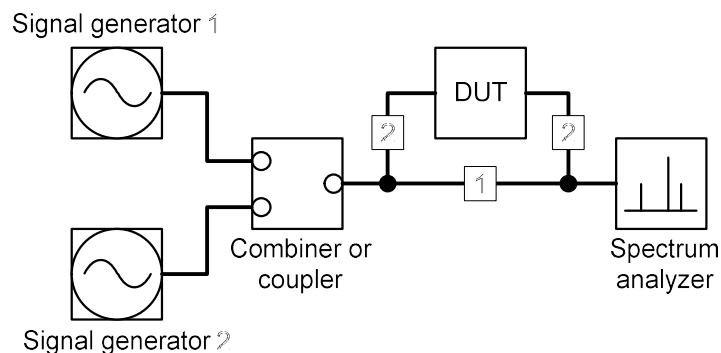

Figure 6: Measurement Setup without (path 1) and with DUT (path 2).

In the following example the fundamentals are centered around 5.2 GHz ($\Delta f = 312.5$ kHz) and have a signal level of -6 dBm each.

At first we focus on the IM products of the spectrum analyzer. Therefore no DUT is in the signal path (path 1 in Figure 6). Therefore, all IM products observed in the analyzer display are generated by the first mixer of the spectrum analyzer. To verify whether the observed IM products are generated within the spectrum analyzer, the amount of input attenuation can be varied. This way the input power to the first mixer is also altered. If the displayed IM products are a result of the analyzers first mixer, then **an increase of input attenuation will decrease the IM products' amplitude** by a factor of two, since the mixer is then operating in a more linear range. Figure 7 shows the results of such a measurement on a R&S FSQ26.

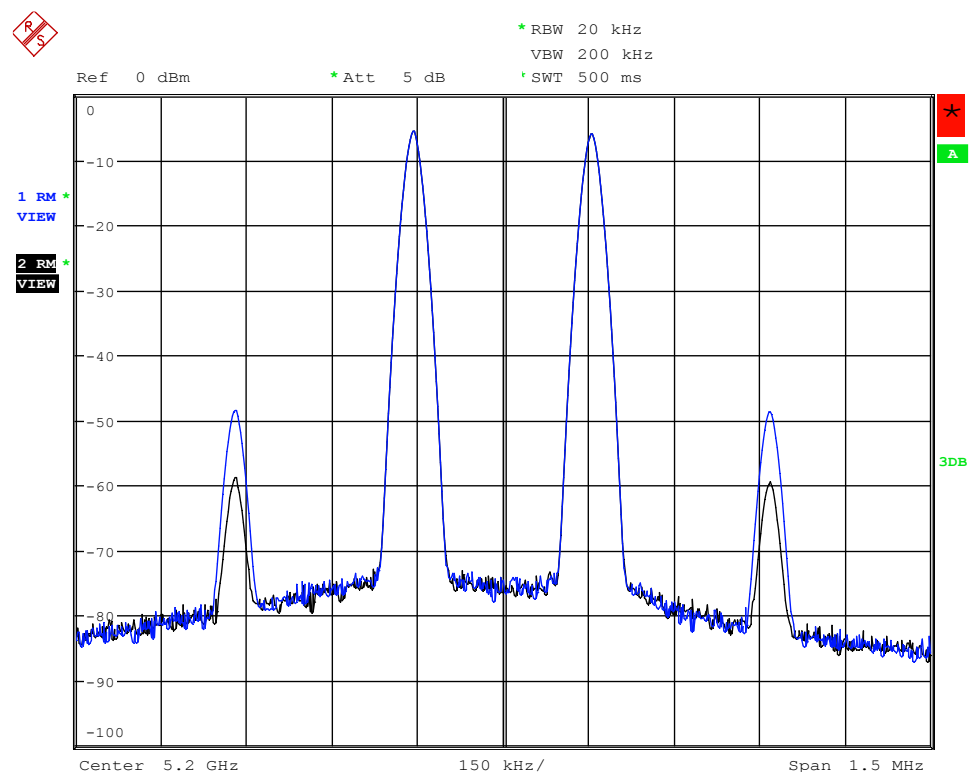

Figure 7: Result of a two-tone measurement without DUT (signal path 1 in Figure 6). An increase of input attenuation results in a decrease of IM products. Blue trace: 0dB input attenuation, black trace: 5dB input attenuation.

In the next step the DUT (wideband power amplifier) is inserted into the signal path (path 2 in Figure 6). Now the DUT and spectrum analyzer will both generate IM products that will interact within the spectrum analyzer. The resultant signals are displayed in Figure 8. The input power to the spectrum analyzer is kept at the same level as in the previous measurement. If in this setup **the input attenuation is increased, the IM products now also increase** as opposed to the previous measurement, where they decreased. This behavior is a consequence of IM products canceling each other because the IM products of DUT and analyzer are of opposite phase. If the input attenuation is increased, the spectrum analyzer contributes less IM products and therefore the cancellation effect eases off.

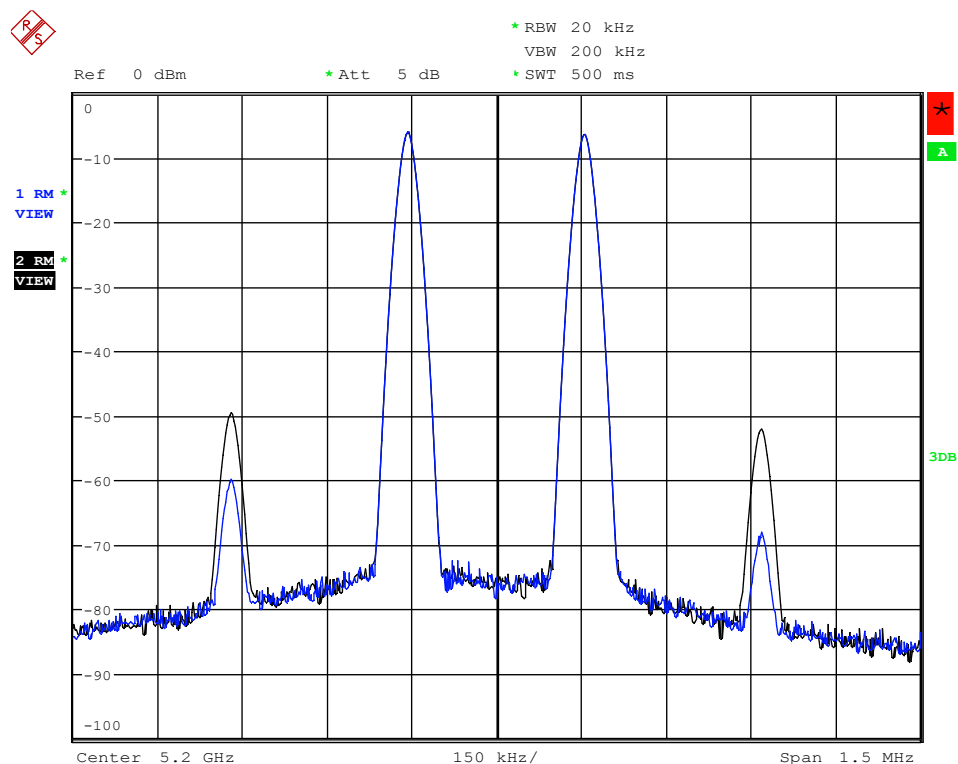

Figure 8: Measurement with DUT (signal path 2 in Figure 6). IM cancellation occurs. An increase of input attenuation also increases IM products since IM cancellation is reduced. Blue trace: 0dB input attenuation, black trace: 5dB input attenuation.

The occurrence of this effect strongly depends on the combination of DUT and spectrum analyzer and the specific phase relation of their IM products. Hence a test with a different type of DUT or spectrum analyzer could result in constructive IM interference. In that case a similar behavior as in Figure 7 would be observed. The IM products contributed by the spectrum analyzer will decrease with additional attenuation until only the DUT's IM products remain. In any case a contribution of the spectrum analyzer to the IM products must be avoided to obtain correct measurements.

The IM cancellation is largely independent of the instantaneous phase relation of the two fundamentals. Instead it mainly depends on the inherent phases of the IM products in both devices which are a result of the component's architecture.

In addition, the cancellation effect is frequency dependent due to the changing phase relation with frequency. Thus the same setup can show varying amounts of IM cancellation, depending on frequency.

Cancelling IM products lead to measurement results that are too optimistic. On the other hand, IM products that constructively interfere result in too pessimistic measurements. This is true for measurements characterizing the DUT's IM distortion like above and also for ACLR and modulation accuracy. An example for an EVM measurement is given in the next section.

1.3 OFDM Example

To show the effect of IM distortion on modulation accuracy in terms of EVM, this example focuses on an OFDM signal. In an OFDM signal all subcarriers are separated Δf apart. So IM products created by any pair of subcarriers will fall at subcarriers left and right of the pair. Thus signal quality in an OFDM signal is strongly influenced by IM distortion. For demonstration purposes a signal with a structure as shown in Figure 9 is utilized. Two carriers with QPSK modulation are followed by two unused carriers and this structure is repeated across frequency several times. IM products of a pair of subcarriers will fall at the frequencies of the unused carriers left and right of the pair. By analyzing the constellation diagram of the unused carriers the signal distortion due to IM products can be seen. Particularly the IM phase, which determines whether constructive or destructive IM interference occurs, can easily be visualized. The expected data points of the unused carriers lie in the origin of the constellation diagram. Additive noise will spread the points around the origin. An IM distortion will shift these points out of the origin. In a real OFDM system unused carriers would not be analyzed, but for demonstration this easily shows the effects of IM cancellation and an EVM value that is too optimistic.

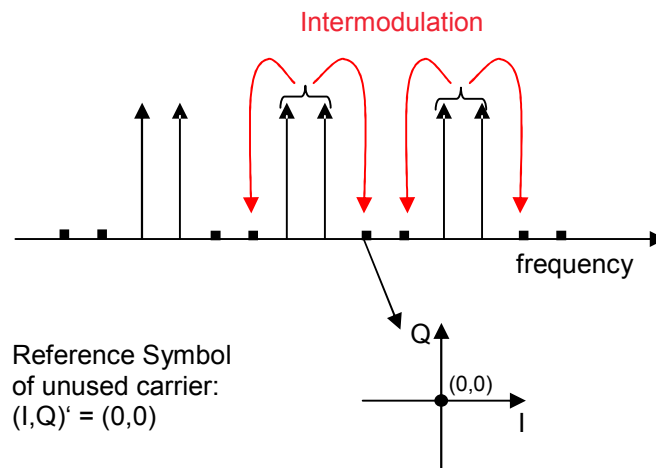

Figure 9: OFDM carrier structure with alternating pairs of active and inactive carriers. Red arrows indicate the position of the resultant IM products.

Figure 10 shows the constellation diagram of an unused carrier for three measurement setups. First a measurement without DUT (signal path 1 in Figure 6) and 0 dB input attenuation is shown (magenta). Here the shifted symbols are a result of the FSQ26's IM products. Next the DUT is put back into the setup (signal path 2) and 5 dB input attenuation is used (blue) so that the spectrum analyzer doesn't contribute to the IM distortion. This way only IM products from the DUT influence the result. In the last step the input attenuation is reduced to 0 dB (red) and the IM products of the DUT and analyzer interact with each other. Due to the opposite phases of the IM products, the IM products interfere destructively and cancellation occurs (compare with Figure 8). The symbols are shifted closer to the ideal symbol at the origin and this results in a significantly reduced EVM. The modulation accuracy of the DUT would hence be overestimated.

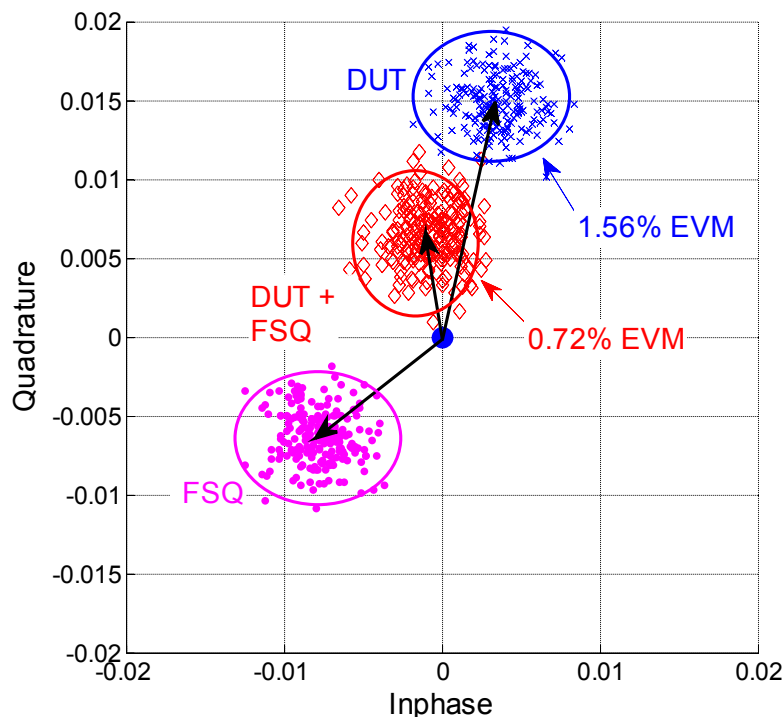

Figure 10: Constellation diagram of an unused carrier showing shifted symbols due to IM distortion for different setups. The reference symbol lies in the center.

2 Estimating IM distortion

The chance of IM cancellation or amplification is given if DUT and spectrum analyzer both have a similar T.O.I. and the IM products are of similar amplitudes. The DUT's true amplitude P_{Δ} will be distorted by the analyzers contribution. It is now the engineers task to decide upon the amount of input attenuation to use in order to reduce the error due to the analyzers IM contribution down to a desired level.

Even though the T.O.I. is listed in the data sheet, it is recommended to measure the actual value with a two-tone signal due to variations in T.O.I. between instruments. In the previous examples the measured T.O.I. of the FSQ26 is 15 dBm and of the DUT 10 dBm. According to equation (2) the amplitudes of the IM products P_{Δ} can be calculated based on the T.O.I.

For an input amplitude of e.g. -10 dBm the FSQ26 generates IM products with $P_{\Delta,SA}=50$ dB (T.O.I.=15 dBm) and the DUT has $P_{\Delta,DUT}=40$ dB (T.O.I.=10 dBm). An IM product of the spectrum analyzer that is only 10 dB below the DUT's IM products can already lead to significant interference, both constructive and destructive, depending on the phase relation.

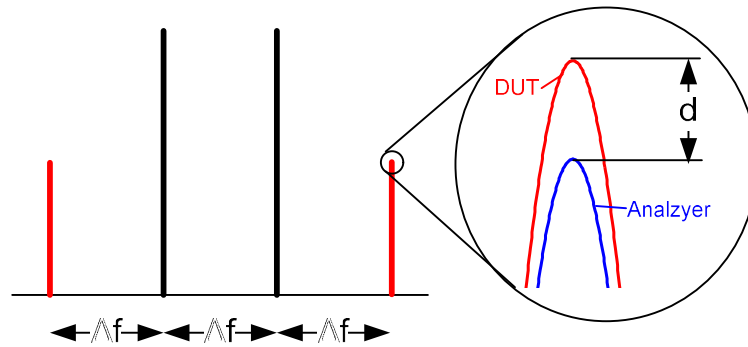

Figure 11: The detailed view shows the difference in IM amplitude between analyzer and DUT.

The resulting amplitude error when the analyzer's and DUT's IM products interfere is given by

$$e_A = 20 \log \left(1 \pm 10^{d/20} \right) \text{dB} \quad (5)$$

where d is the negative amplitude difference between the IM products of the analyzer and DUT in dB, -10 dB in the above example (see Figure 11). For in-phase IM products the elements in equation (5) within brackets are added whereas for opposite phase products they are subtracted. For the above example we get (IM cancellation due to opposite phases assumed)

$$e_A = 20 \log \left(1 - 10^{-10/20} \right) = -3.3 \text{dB}$$

meaning that the amplitude of the DUT's IM products are 3.3dB lower than expected.

To avoid interference, the input power to the analyzer's mixer must be reduced so that the amplitudes of the IM products are lowered. This is done by adding sufficient input attenuation. Adding e.g. 10 dB attenuation in the above example also reduces P_{in} by 10 dB to -20dBm and $P_{\Delta,SA}=70$ dB. $P_{\Delta,DUT}$ stays at 40 dB. Now the IM products of the spectrum analyzer lie 30 dB below the DUT's and the amplitude error reduces to

$$e_A = 20 \log \left(1 - 10^{-30/20} \right) = -0.3 \text{dB}$$

Figure 12 shows the relation between the amplitude difference d and the resulting error e_A , both for in-phase and opposite phase interference. Equal amplitudes ($d=0$ dB) would result in a complete cancellation of amplitudes and therefore an infinite error in dB.

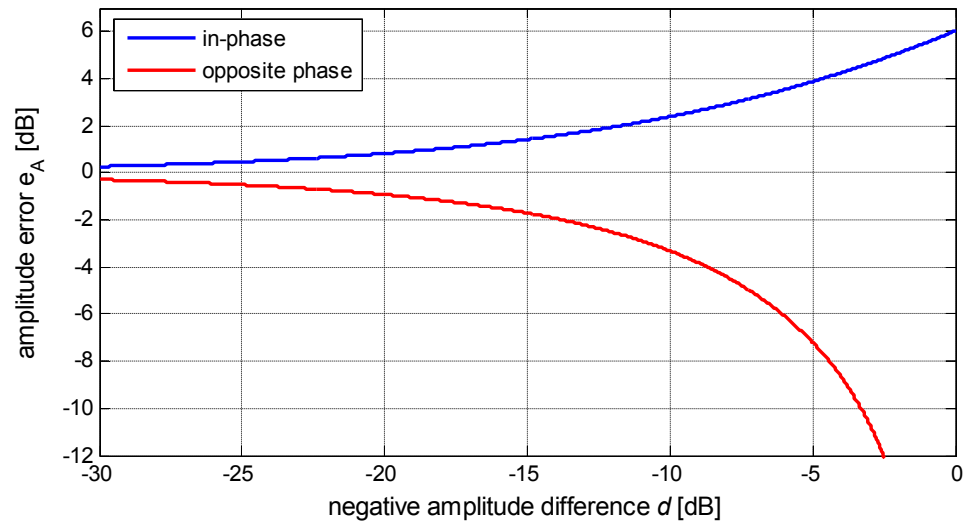

Figure 12: Amplitude difference between IM products of a DUT and spectrum analyzer and resulting amplitude error for the 3rd order IM products.

An engineer would most likely first define a maximal allowable amplitude error e_A for his application and read the necessary amplitude difference d_{goal} from Figure 12 or calculate it as

- IM amplification: $d_{goal} = 20 \log\left(10^{e_A/20} - 1\right) dB$
- IM cancellation: $d_{goal} = 20 \log\left(1 - 10^{e_A/20}\right) dB$

Based on equation (2) P_Δ for DUT and analyzer can be calculated. If the current amplitude difference $d_{curr} = P_{\Delta,SA} - P_{\Delta,DUT}$ is lower than d_{goal} , the mixer level must be lowered in order to also reduce the analyzers IM products. Thereby the optimum mixer level shifts to a lower value. This can be expressed as an effective T.O.I. that is lowered by $d/2$

$$TOI_{eff} = TOI - d_{goal} / 2 \quad (6)$$

For the example with $d_{goal} = 30dB$, $d_{curr} = 10dB$ and $TOI = 15dBm$, the effective TOI is $0dBm$. The dynamic range chart can now be redrawn with the altered values (see Figure 13). It can be seen how the amplitude error requirement shifts the 3rd order IM curve up by d_{goal} and how the optimum mixer level shifts to a lower value accordingly. However, this will also reduce the dynamic range.

The additional attenuation that needs to be added for reducing the mixer level by the required amount is

$$Att = \frac{1}{2} (d_{goal} - d_{curr}) dB \quad (7)$$

10dB in the above example.

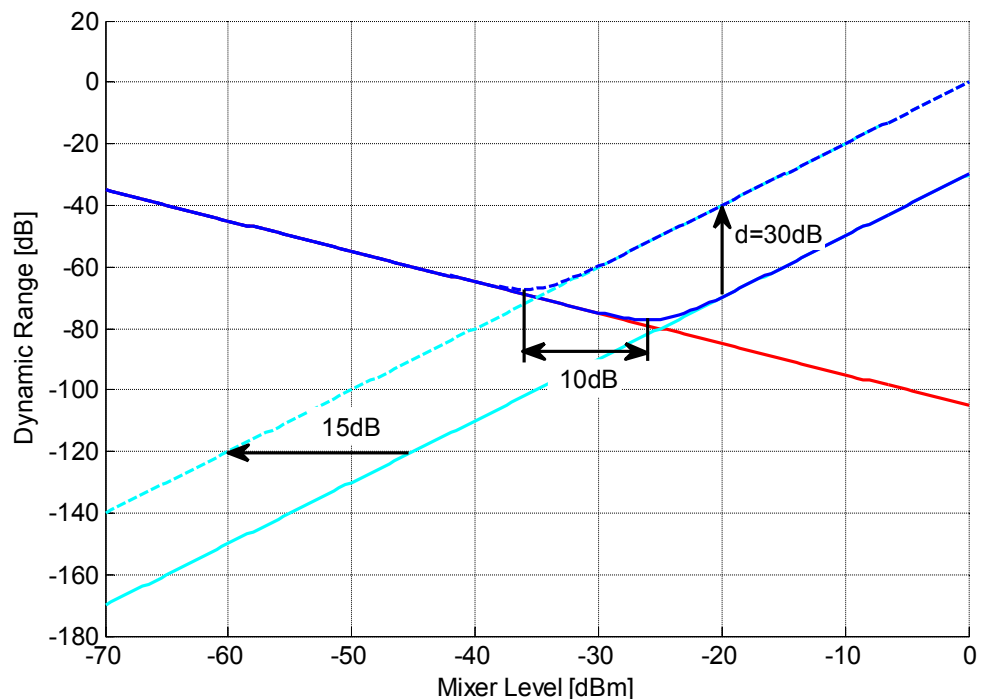

Figure 13: Dynamic Range Chart with additional 10dB attenuation to achieve -0.3dB amplitude error. A 15dB loss in effective TOI occurs and the optimum mixer level shifts down by 10dB. The dynamic range reduces accordingly. (signal bandwidth 100kHz, $TOI_{eff} = 0\text{dBm}$).

3 Conclusion

Interfering IM products of a DUT and spectrum analyzer can result in distorted measurements, not only for intermodulation measurements but also ACLR or modulation accuracy. Care has to be taken when IM products of the DUT and analyzer are of similar amplitude since this can lead to distorted measurements. Depending on whether constructive or destructive IM interference occurs, the displayed results can be worse or also better than the real DUT performance.

To reduce the analyzers influence on IM distortion, the mixer level must be lowered so that a tolerable error is reached. To do so, additional input attenuation must be used. To verify for a given measurement setup that the analyzers contribution to the IM distortion is negligible, a two-tone measurement can be used to check for IM cancellation or amplification. This way the amplitude error originating from interfering IM products can be estimated.

The different architectures of spectrum analyzers decide upon the propensity of IM distortion. Analyzers like the R&S FSW or R&S FSQ8 are less likely to add IM products to the measurement since they have a considerably higher T.O.I. of typically 20 dBm and 23 dBm, respectively. For these analyzers less input attenuation needs to be added to protect the input mixer which also results in a higher dynamic range.

4 Literature

- [1] *Fundamentals of Spectrum Analysis*. C. Rauscher, Rohde & Schwarz, 2001
- [2] *Measurement of Harmonics using Spectrum Analyzers*. Application Note 1EF78, 2012
- [3] *Intermodulation Distortion Measurements on Modern Spectrum Analyzers*. Application Note 1EF79, 2012

5 Ordering Information

Designation	Type	Order Number
R&S FSW8	Signal and Spectrum analyzer 2 Hz to 8 GHz	1312.8000.08
R&S FSW13	Signal and Spectrum analyzer 2 Hz to 13.6 GHz	1312.8000.13
R&S FSW26	Signal and Spectrum analyzer 2 Hz to 26.5 GHz	1312.8000.26
R&S FSW43	Signal and Spectrum analyzer 2 Hz to 43.5 GHz	1312.8000.43
R&S FSQ8	Signal analyzer 20 Hz to 8 GHz	1313.9100.08
R&S FSQ26	Signal analyzer 20 Hz to 26.5 GHz	1313.9100.26
R&S FSQ40	Signal analyzer 20 Hz to 40 GHz	1313.9100.40

About Rohde & Schwarz

Rohde & Schwarz is an independent group of companies specializing in electronics. It is a leading supplier of solutions in the fields of test and measurement, broadcasting, radiomonitoring and radiolocation, as well as secure communications. Established more than 75 years ago, Rohde & Schwarz has a global presence and a dedicated service network in over 70 countries. Company headquarters are in Munich, Germany.

Environmental commitment

- Energy-efficient products
- Continuous improvement in environmental sustainability
- ISO 14001-certified environmental management system



Regional contact

Europe, Africa, Middle East

+49 89 4129 12345

customersupport@rohde-schwarz.com

North America

1-888-TEST-RSA (1-888-837-8772)

customer.support@rsa.rohde-schwarz.com

Latin America

+1-410-910-7988

customersupport.la@rohde-schwarz.com

Asia/Pacific

+65 65 13 04 88

customersupport.asia@rohde-schwarz.com

China

+86-800-810-8228 / +86-400-650-5896

customersupport.china@rohde-schwarz.com

This application note and the supplied programs may only be used subject to the conditions of use set forth in the download area of the Rohde & Schwarz website.

R&S® is a registered trademark of Rohde & Schwarz GmbH & Co. KG; Trade names are trademarks of the owners.

Rohde & Schwarz GmbH & Co. KG

Mühlhofstraße 15 | D - 81671 München

Phone + 49 89 4129 - 0 | Fax + 49 89 4129 - 13777

www.rohde-schwarz.com