



Products: R&S FSUP, R&S FSU, R&S FSQ, R&S FSP, R&S FSV, R&S FSW

# Time Domain Oscillator Stability Measurement Allan variance

## Application Note

This application note gives a short summary on the Allan variance as a measure of frequency stability and an example on how to calculate it, with measurement results from R&S spectrum analyzers.

A software program to sample data from R&S spectrum analyzers and calculate the Allan variance is available.



## Content

|    |   |    |
|----|---|----|
| 1  | Introduction: frequency stability and accuracy .....          | 2  |
| 2  | Measurement methods .....                                     | 4  |
|    | Beat Frequency method.....                                    | 4  |
|    | Advantages .....  | 4  |
|    | Restrictions .....  | 4  |
|    | Spectrum analyzer method .....                                | 5  |
|    | Advantages .....  | 5  |
|    | Restrictions .....  | 5  |
|    | PLL method.....   | 6  |
|    | Advantages .....  | 6  |
|    | Restrictions .....  | 6  |
| 3  | The Allan variance.....                                       | 7  |
|    | Expressing frequency fluctuations as the Allan variance ..... | 7  |
|    | Converting phase noise data into the Allan variance .....     | 8  |
| 4  | Using a spectrum analyzer for Allan variance measurement..... | 8  |
| 5  | Installing the software.....                                  | 9  |
|    | Prerequisites .....   | 9  |
|    | Installation .....  | 9  |
| 6  | Running the program .....                                     | 9  |
|    | General settings.....   | 9  |
|    | General section .....   | 10 |
|    | Frequency counter mode .....                                  | 11 |
|    | Phase noise mode .....  | 11 |
|    | Analog demodulation (K7) mode .....                           | 12 |
| 7  | Interpreting the results .....                                | 12 |
|    | Frequency counter method .....                                | 12 |
|    | Phase noise method .....                                      | 13 |
|    | Analog demodulation (K7) method .....                         | 13 |
|    | Noise processes .....   | 14 |
| 8  | Literature .....  | 15 |
| 9  | Additional Information .....                                  | 16 |
| 10 | Ordering Information .....                                    | 16 |

## 1 Introduction: frequency stability and accuracy

When it comes to characterizing an oscillator, frequency stability and accuracy are key values.

Accuracy in general describes the deviation of a measurement value, be it a single value or an average, from the standard of the quantity being measured. The accuracy of an oscillator is in general given in ppm.

Stability on the other hand describes the variation of measurement samples and therefore can only be calculated for a set of measurement values.

Frequency stability of an oscillator is typically characterized as its phase noise. Precisely, the single side band phase noise over the offset frequency or the integrated single side band phase noise as a scalar value. The single side band (SSB) phase noise fully specifies a source, as the phase noise trace is axially symmetric with regard to the oscillator frequency. The SSB phase noise is the amount of power located in a bandwidth  $B$  around an offset frequency  $f$  that results from phase changes of the oscillator under test. The phase noise value is usually normalized to  $B = 1$  Hz of bandwidth.

## Measuring the Allan variance

---

Specifying the phase noise of an oscillator is equivalent to specifying the frequency noise, as the normalized or fractional frequency (to the nominal carrier frequency) can be directly derived from the phase as the instantaneous frequency  $\nu(t)$  can be written as

$$\nu(t) = \nu_0 + \frac{1}{2\pi} \frac{d}{dt} \varphi(t),$$

with  $\varphi(t)$  the instantaneous phase.

A number of methods to measure phase or frequency noise exist, but most of them measure phase fluctuations. Therefore phase noise is specified for most oscillators.

With regard to spectrum analyzer usage for oscillator stability measurements, the following three methods are described briefly in chapter 2.

- 1) Beat frequency method or heterodyne frequency measuring.
- 2) Spectrum analyzer method.
- 3) Phase locked loop method (signal source analyzer method).

Alternatively to the spectral domain based phase noise characterization, oscillator stability can also be specified in the time domain. Stability in the time domain can be characterized using the two-sample or Allan variance. It plots the variance of two samples over the time that separates these two samples.

As both domains characterize the same property, the frequency domain representation of the oscillator stability can be converted into the time domain representation and vice versa. Formulas for the most common conversions are given in chapter 3. For a detailed view on the mathematical background, have a look at the references.

The following notation is used in this document.

|                |   |
|----------------|---|
| f              | Offset frequency (Hz)   |
| $\nu$          | Oscillator center frequency (Hz)  |
| y              | Fractional frequency  |
| $S_y(f)$       | Spectral density of fractional frequency fluctuations (1/Hz)            |
| $S_\varphi(f)$ | Spectral density of phase fluctuations (rad <sup>2</sup> /Hz)           |
| $\sigma_y(t)$  | Allan standard deviation, square root of Allan variance $\sigma_y^2(t)$ |
| L(f)           | Single side band noise (1/Hz)   |
| $L_{dBc}(f)$   | Single side band noise, logarithmic scale (dBc/Hz)                      |
| $S_\nu(f)$     | Spectral density of frequency fluctuations (Hz <sup>2</sup> /Hz)        |

## 2 Measurement methods

### Beat Frequency method

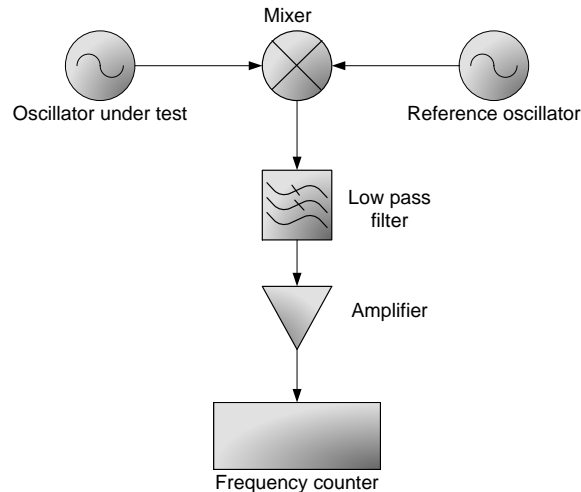

Figure 1 Frequency fluctuation measurement using the beat frequency method

One method to directly measure frequency fluctuations is the beat frequency method as shown in Figure 1. The signal of the oscillator under test is down converted using a reference oscillator. The down converted and amplified signal is fed into a frequency counter. A spectrum analyzer's built in frequency counter may be used. This method is used by the frequency counter and the analog demodulation method of the "R&S Allan Variance Tool". The speed of frequency counters depends in general on the counter resolution. When counting zero crossings, the measurement time is roughly  $1/(\text{resolution})$ , i.e. 10 seconds for 0.1 Hz counter resolution. With digital resolution bandwidth filters, the frequency counter measurement time becomes independent of the counter resolution. For the R&S FSP for example, the frequency estimation with  $\text{RBW} \leq 100 \text{ kHz}$  takes around 30 ms, regardless of the counter resolution.

The beat frequency method is the standard method to measure Allan variance, or more precisely to measure the frequency deviation of the DUT from the frequency standard.

#### Advantages

- Depending on the frequency counter accuracy, this method provides high precision
- AM noise is not taken into account

#### Restrictions

- Slow

### Spectrum analyzer method

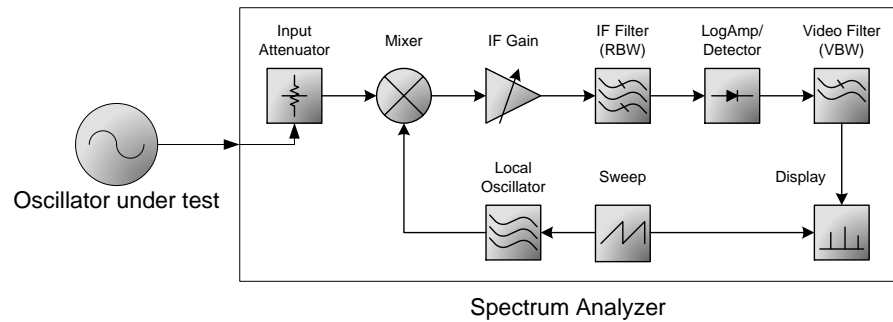

Figure 2 Phase noise measurement using a spectrum analyzer

The total power at the respective offset frequency is read from the spectrum analyzer display. To transfer the spectral power into a phase noise plot, it must be ensured that the AM noise can be neglected. AM noise results from varying output power of either the oscillator under test or the reference oscillator. If this prerequisite is not met, the varying amplitude causes an amplitude modulation. In this case, the AM spectral components are added to the phase noise components and cannot be separated with this measurement method. In addition to AM noise, the spectrum analyzer method is not suitable for phase noise measurements at small offset frequencies or for heavily drifting signals. The smallest offset frequency depends on the smallest resolution bandwidth available on the spectrum analyzer. The maximum allowable drift depends on the measurement speed of the analyzer for a sweep over the offset range of interest. The big advantage of this method is the quick and easy configuration as well as the availability and cost of spectrum analyzers compared to phase noise testers.

#### Advantages

- Easy operation
- Availability and cost of spectrum analyzers

#### Restrictions

- No distinction between phase noise and AM noise
- Phase noise at small offset frequencies cannot be measured
- Heavily drifting signals cannot be measured
- Restricted by LO phase noise

### PLL method

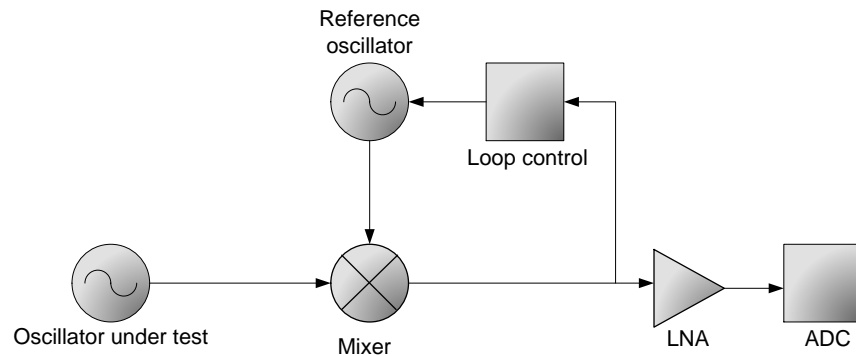

Figure 3 Signal source analyzer method (PLL method)

The phase locked loop method is utilized by most signal source analyzers, i.e. measurement instruments that are designed for phase noise measurements. It is also referred to as direct homodyne method. The loop control locks the reference oscillator to a 90 degree phase shift compared to the input signal. Therefore, the mixer is operated at its highest sensitivity for phase fluctuations and also suppresses amplitude variations, which cause AM noise. Some devices also comprise a harmonic generator. It would be located between the DUT and the mixer. The harmonic generator avoids dividers in the reference path for low input frequencies. Dividers in the reference path increase the phase noise of the reference oscillator and therefore reduce the measurement sensitivity of the analyzer. This concept, also referred to as phase noise tester concept, overcomes the limitations of the spectrum analyzer method at the cost of an increased price compared to a spectrum analyzer. Clearly, by locking the loop onto the oscillator under test, this method is not sensitive to frequency changes within the loop bandwidth.

#### Advantages

- Separates phase noise from AM noise
- Phase noise measurement to large offsets, even for strongly drifting carriers
- Carrier suppression, therefore small offsets can be measured

#### Restrictions

- Complex settings and calibration

### 3 The Allan variance

#### Expressing frequency fluctuations as the Allan variance

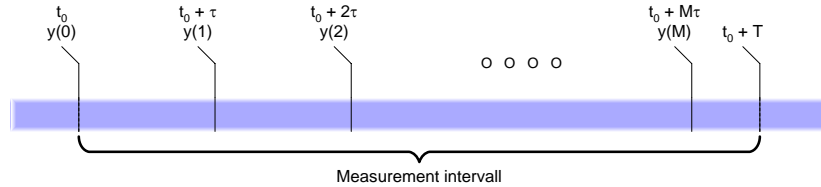

Figure 4 Time line for frequency counter measurements

The Allan-, or 2-sample variance is a measure for the stability of an oscillator in the time domain. It is the variance of the difference of two fractional frequency values  $y(i+1)$  and  $y(i)$ . The fractional frequency  $y(i)$  was measured at time  $t_0+i*\tau$ , and  $y(i+1)$  at  $t_0+(i+1)*\tau$ , respectively. The Allan variance  $\sigma_y^2(\tau)$  depends on the variable  $\tau$  and expresses the mean square of all frequency counter samples separated in time by  $\tau$  over the entire measurement interval  $T$ , i.e.  $[t_0 \ t_0 + T]$ . Figure 4 illustrates the time interval. Expressed mathematically,

$$\sigma_y(\tau) = \left[ \frac{1}{2M} \sum_{i=0}^{M-1} (y(i+1) - y(i))^2 \right]^{1/2} \quad (3.1)$$

with  $M = \left\lfloor \frac{T}{\tau} \right\rfloor - 1$ , and

$$y(i) = \frac{\langle \nu_1(t_0 + i \cdot \tau) \rangle_\tau - \nu_0}{\nu_0} \quad (3.2)$$

the fractional frequency at sample time  $t_0+i*\tau$ .  $\langle \nu_1(t) \rangle_\tau$  denotes the current frequency of the DUT, averaged over a time interval  $\tau$ , whereas  $\nu_0$  is the frequency of the reference oscillator

In words, the Allan variance is the variance of  $M$  pairs of frequency measurements that were taken at times  $t$ , and  $t+\tau$ , respectively.

A significant contribution to the measurement uncertainty results from the reference oscillator. Therefore it is recommended to use a reference oscillator that is at least an order of magnitude more stable than the DUT.

When calculating the Allan variance from frequency counter samples of a spectrum analyzer, the measurement uncertainty depends not only on the frequency accuracy of the counter, but also on the accuracy of  $\tau$ , i.e. the timing precision between two measurements.

As mentioned above, the Allan variance describes the stability of an oscillator compared to a reference. To determine the oscillator frequency, the frequency counter functionality of a spectrum analyzer can be used. The DUT frequency is determined against the spectrum analyzer reference, which is either an internal TCXO, OCXO, or an external reference.

### Converting phase noise data into the Allan variance

As the Allan variance is a measure for oscillator stability, it can also be derived from phase noise data. With e.g. a single sideband phase noise trace from an R&S FSUP signal source analyzer, or an R&S FS-K40 firmware option, the Allan variance can be calculated using the following dependencies.

The equations below use  $L(f)$ , the linear single side band phase noise, which relates to the common logarithmic scale SSB phase noise as:

$$L(f) = 10^{L_{\text{dBc}}(f)/10} \quad (3.3)$$

From the linear SSB trace, the spectral density of the fractional frequency can be calculated using

$$S_y(f) = 2 \frac{f^2}{v_0^2} L(f) = \frac{f^2}{v_0^2} S_\phi(f) \quad (3.4)$$

if

$$\int_f^\infty S_\phi(f') \cdot df' \ll 1 \text{ rad}^2 \quad (3.5)$$

This condition makes sure that the noise power, located above the highest offset frequency under investigation, is small.

With  $S_y(f)$  known from the above equation, the Allan variance can be derived numerically using

$$\sigma_y^2(\tau) = 2 \int_0^{f_h} S_y(f) \frac{\sin^4(\pi\tau f)}{(\pi\tau f)^2} df \quad (3.6)$$

The derivation of this equation can be found in [1] and [2].

This method is recommended for small  $\tau$ , as the measurement uncertainty for frequency counter measurements with regard to  $\tau$  becomes dominant for  $\tau < 0.1$  s (measurement time for the digital frequency counter approximately 30 ms).

## 4 Using a spectrum analyzer for Allan variance measurement

The R&S Allan variance tool that can be downloaded together with this application note from the R&S website supports the acquisition of measurement data and the calculation of the Allan variance. The program supports three methods to gather the measurement data. The first method is the frequency counter method. It uses the built in frequency counter that is available on all R&S spectrum analyzers. The measure of this method is the absolute frequency in Hertz. The second method is the phase noise



## Measuring the Allan variance

---

method. It reads a phase noise trace from the R&S FSUP and converts it into Allan variance. The third method is similar to method one. Instead of using the frequency counter, this method reads the frequencies from the analog demodulation option. This option (FS-K7) delivers the frequency variation (frequency modulation) around a given carrier. With the known carrier, the absolute frequency and thereafter the Allan variance may be calculated.

To use the program together with an R&S spectrum analyzer, a VISA library needs to be installed on the remote control.

The hardware setup is identical for all modes. Connect your DUT to the RF Input port of the R&S spectrum analyzer. In case an external frequency reference is necessary, connect the reference to the “REF IN” port of the R&S spectrum analyzer. Connect the analyzer via GPIB or LAN to your remote control PC. The setup is depicted in Figure 5.

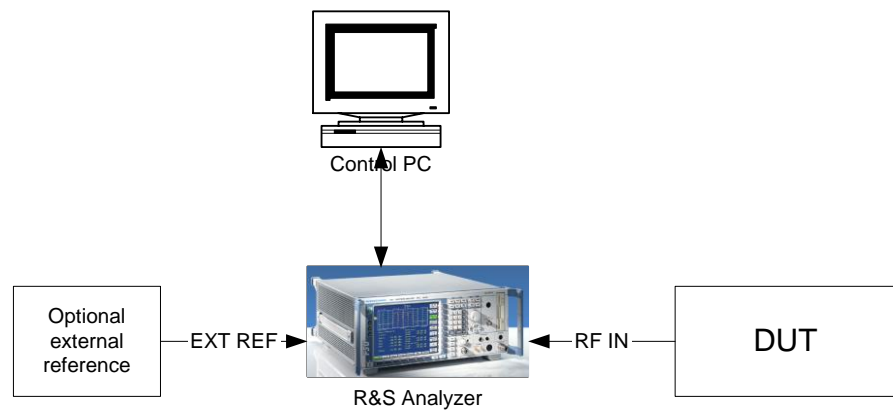

Figure 5 Measurement setup for frequency counter derived Allan variance

## 5 Installing the software

### Prerequisites

The software requires a Windows PC. To connect to an R&S spectrum analyzer, an installed VISA library is necessary. The connection may be either GPIB or LAN.

### Installation

Unzip the installation package to a folder and start “AllanVariance.exe”.

## 6 Running the program

### General settings

The R&S Allan Variance Tool can be operated in three modes.

The frequency counter mode supports the sampling of frequency measurements as well as the mathematical operations required to transform the frequency data into the 2-sample or Allan variance.

## Measuring the Allan variance

The phase noise mode reads trace data from the FSUP and converts it into Allan variance.

The analog demodulation method is similar to the frequency counter method, but instead of reading the frequency counter result, the FM result display trace from the analog demodulation option is read.

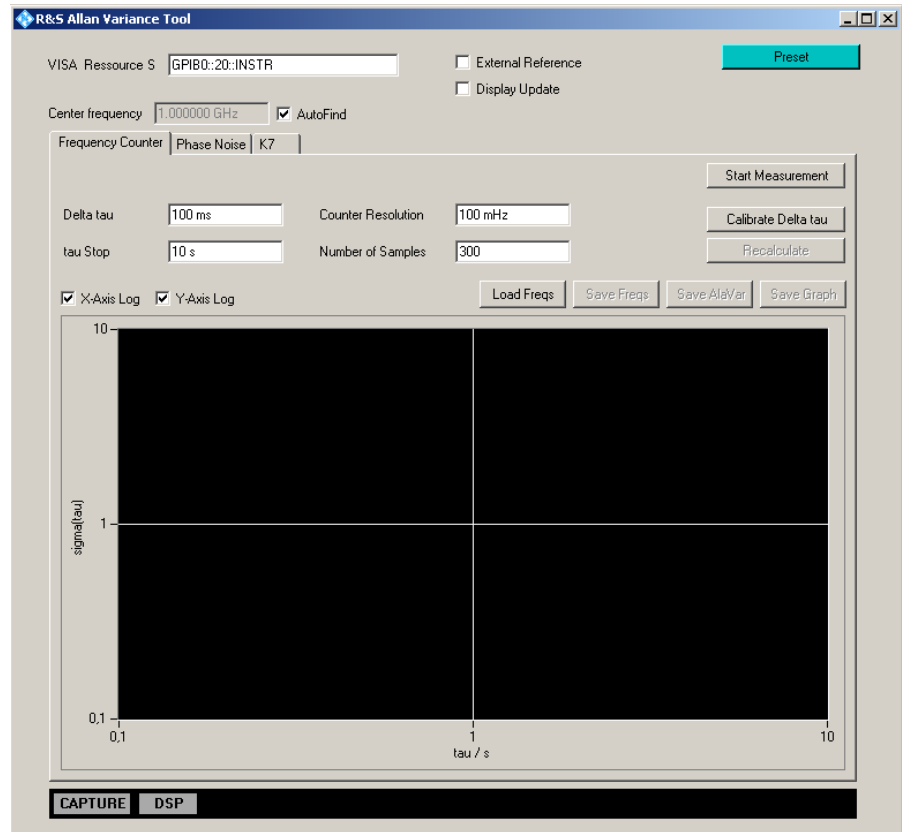

Figure 6 Program at startup

### General section

The common section of the program allows to setup communication parameters of the analyzer in use. The VISA resource string identifies the interface and the address of the analyzer. It is made up by an interface identifier, the instrument address, and the key-word "INSTR", where each part is separated by a double colon "::". An R&S spectrum analyzer connected via LAN with address 192.168.1.5 can be specified as shown in Figure 6.

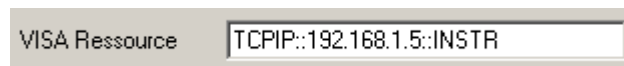

Figure 7 VISA resource string

Besides the VISA resource string, the parameters External Reference, Display Update and Center Frequency can be configured.

To lock the analyzer to an external reference signal, simply check the respective check box.

## Measuring the Allan variance

---

Display Update configures the behavior of the analyzer display during measurement. If checked, the display will be updated during the measurement, otherwise it does not display the current measurement, which results in a higher measurement speed.

The Center frequency text box displays the current center frequency of the analyzer in use. If the checkbox *AutoFind* is activated, the textbox cannot be edited, but will be filled by the program automatically. The *AutoFind* routine sets the analyzer to the strongest signal within the input frequency band of the analyzer.

In general, each tab of the program contains its own graph and input area, i.e. data can be acquired and calculated in each tab separately.

### Frequency counter mode

The frequency counter mode offers the following settings:

- Delta tau
- Tau stop
- Counter resolution
- Number of samples

The parameters *Delta tau* and *tau stop* define the scaling of the x-axis of the Allan variance plot. Depending on whether the *X-Axis Log* check box is checked or not, the program creates a  $\tau$ -vector from *Delta tau* to *Tau stop*, with either linear or logarithmic steps.

The *Calibrate Delta tau* button measures the time required by the analyzer to do a frequency counter measurement with the specified resolution. After having determined the minimum *Delta tau*, the textbox will not allow values smaller than the minimum. The value for the *Counter Resolution* is limited by the frequency counter built into your spectrum analyzer. In case a value smaller than the minimum *Delta tau* was entered before the calibration, the value in the textbox will automatically be increased.

The *Start Measurement* button starts the measurement. It automatically initiates a *Delta tau* calibration before it starts the measurement.

The *tau Stop* value and the *Number of Samples* do have a dependency. The program requires a measurement time that is at least three times as large as your specified stop parameter for the Allan variance (*tau Stop*). This limitation is necessary to have enough input data for the calculation.

The buttons *Load Freqs*, and *Save Freqs* enable you to store and load raw data, i.e. the readings from the frequency counter, into a file. Instead of sampling the frequency values, you may load them from a file and thereafter hit the *ReCalculate* button to start the calculation. The result data can also be stored either as comma separated values or as an image.

### Phase noise mode

Phase noise mode allows only the following settings:

- Delta tau
- Tau stop

In phase noise mode, the program does not control any settings of the phase noise measurement. The program only checks, whether a FSUP is connected and performs a single sweep in phase noise mode. The button

Check Settings will only issue a warning, when the selected *Delta tau* and *Tau stop* values are far off reasonable values.

The buttons *Load Trace* and *Save Trace* correspond to the *Load Freqs* and *Save Freqs* buttons of the frequency counter mode. The buttons *ReCalculate*, *Save AlaVar*, and *Save Graph* are identical in their functionality.

### Analog demodulation (K7) mode

The analog demodulation mode allows the following settings:

- Delta tau
- Tau stop

In addition, it displays *Demod BW* and *Number of Samples*. These values are read only. The parameter *Delta tau* is the reciprocal value of the sampling frequency set in the analog demod option. The sampling frequency depends on the demodulation bandwidth. Demod BW is a parameter the user can set in the analog demod option and is therefore displayed as a read only value in the program. As sampling frequency is only set to discrete values by the analog demod option, the same applies to *Delta tau*. *Tau stop* on the other hand, is limited by the maximum number of samples that the analyzer's analog demodulation option can measure. It is limited by the analyzer IQ memory size.

The buttons *Load Trace*, *Save Trace*, *Save AlaVar*, *Save Graph*, and *ReCalculate* have the same functionality as in phase noise mode.

## 7 Interpreting the results

To find the ideal measurement method for a given range of  $\tau$ , it is important to know the limitations of each method.

### Frequency counter method

The frequency counter method is based on (3.1). It requires frequency measurements as the input variable.

The frequency counter method has two major limitations: on the one hand, the minimum  $\Delta\tau$  is limited by the measurement time of the frequency counter. Using an FSUP, the measurement time, including the transfer time to the PC, is approximately 1.2 s, therefore  $\Delta\tau$  is also limited to 1.2 s. On the other hand, the resolution of the frequency counter is limited to 0.1 Hz for the FSP and FSU families and 1 mHz for the FSV. This leads to a measurement uncertainty of roughly  $10^{-10}$  (std. dev.) for FSP and FSU, and  $10^{-12}$  (std. dev.) for the FSV, both for a 1 GHz source. With constant frequency counter resolution, the measurement uncertainty decreases with an increasing signal frequency.

The big advantage of the frequency counter method is the total measurement time and therefore the maximum  $\tau$  that can be calculated. The total measurement time is only restricted by the PC memory that holds the measurement results. Figure 8 shows good results for  $\tau > 10$  s, using a  $\Delta\tau$  of 1.2 s. This is caused by the averaging of the fractional frequencies for  $\tau > \Delta\tau$ , as described in section 3.

### Phase noise method

The phase noise method reads a phase noise trace from a connected FSUP. It does not do any settings on the FSUP, except the external reference setting. Thereafter, one sweep is initiated and the trace read.

The program uses (3.6) to calculate the Allan variance. The results are only valid if the condition in (3.5) is obeyed.

Figure 8 shows the Allan std. deviation calculated from an FSUP trace in blue color. The phase noise measurement was taken from 1 Hz offset to 30 MHz offset, with a loop bandwidth of 100 Hz. It delivers good Allan std. dev. results to about 0.1 s. At the lower end, it can be assumed that it delivers good results to about 100 ns, which is one order of magnitude larger than the inverse of the stop offset frequency.

Clearly, the phase noise conversion method is best suited for small  $\tau$ .

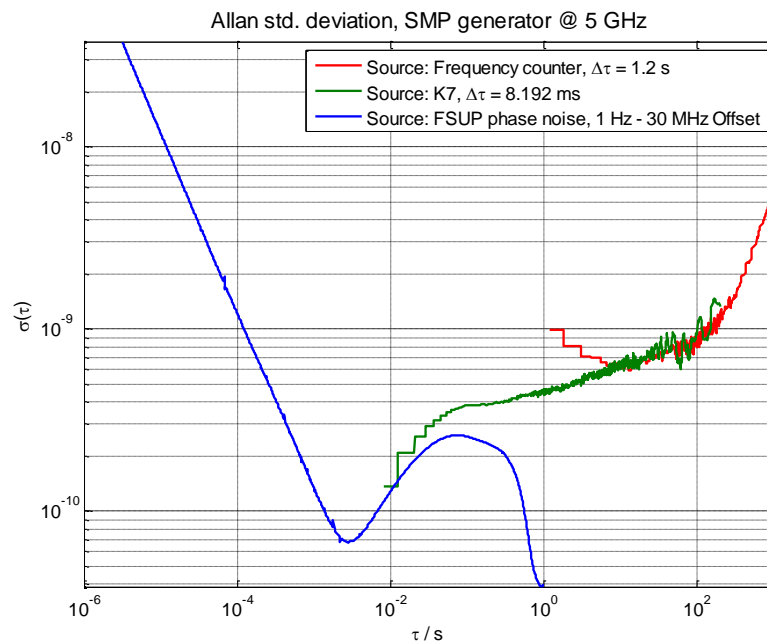

Figure 8 Comparison of Allan std. deviation calculated from all three possible sources (frequency counter, analog demod, FSUP phase noise)

### Analog demodulation (K7) method

The third method using the FS-K7 option is based on the same mathematical algorithm than the frequency counter method. Unlike the frequency counter method, the input variable frequency is taken from the FM result of the analog demod option.

The big advantage of this option is the high sampling rates that are possible.  $\Delta\tau$  can be selected from 31.25 ns to 8.192 ms. Compared to the frequency counter, the analog demodulation option has another advantage. The number of significant digits of the frequency readout is higher, which leads to an increased measurement uncertainty of around 3 orders of magnitude compared to the frequency counter mode.

## Measuring the Allan variance

---

The limitation when using the analog demodulation option is the limited maximum  $\tau$ . It is determined by the IQ-memory size of the analyzer in use, which is represented by the maximum measurement time of the analog demod option. It depends not only on the memory size but also on the selected sampling rate, i.e.  $\Delta\tau$ .

### Noise processes

The noise processes that make up phase noise are usually divided up into 5 categories, based on their frequency or time dependence. Noise processes in depth will not be discussed here, but identifying the same noise process in the phase noise trace and in the Allan variance trace helps a lot when it comes to verification of the Allan variance plot. As mentioned before, the phase noise method allows to calculate any  $\tau$  range from a given phase noise trace. Clearly, appropriate results for  $\sigma^2$  can be obtained only if the selected start and stop offset frequencies cover the main spectral components of the noise process. The table below lists the five main noise processes and their dependency on  $\tau$  and  $f$ , for the traces of phase noise, Allan std. deviation, and spectral density of fractional frequency fluctuations.

|                       | <b>L(f)</b> | <b>S<sub>y</sub>(f)</b> | <b>σ(τ)</b>   |
|-----------------------|-------------|-------------------------|---------------|
| Random walk frequency | $f^{-4}$    | $f^{-2}$                | $\tau^{0.5}$  |
| Flicker frequency     | $f^{-3}$    | $f^{-1}$                | $\tau^0$      |
| White frequency       | $f^{-2}$    | $f^0$                   | $\tau^{-0.5}$ |
| Flicker phase         | $f^{-1}$    | $f^1$                   | $\tau^{-1}$   |
| White phase           | $f^0$       | $f^2$                   | $\tau^{-1}$   |

Each process that was identified in the phase noise trace should also be identifiable in the Allan variance trace. Figures Figure 9 and Figure 10 show the phase noise plot and Allan std. deviation plot of a Pascall 100 MHz OCXO. Figure Figure 10 was calculated from the data of figure Figure 9. Both figures contain a blue measured or calculated trace and colored asymptotes for each noise process.

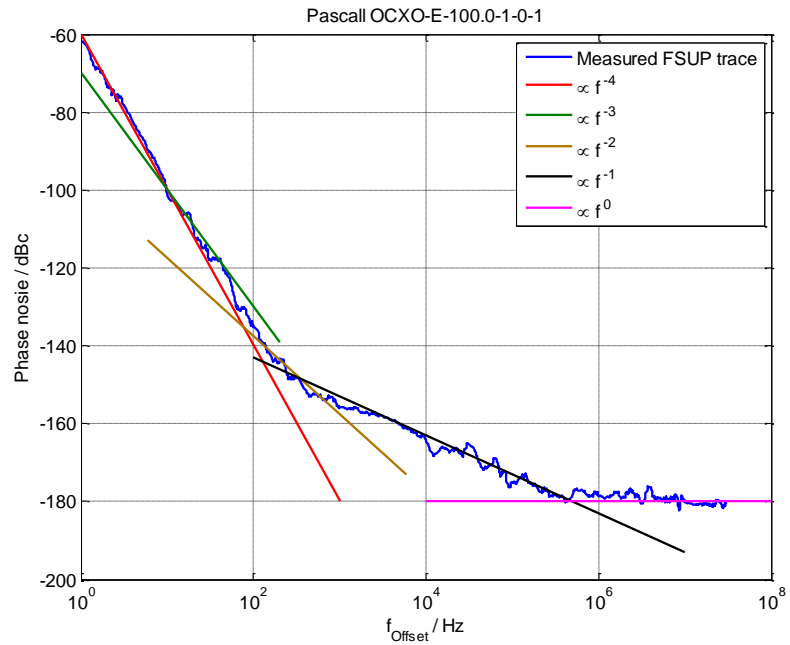

Figure 9 Phase noise plot with marked up noise processes

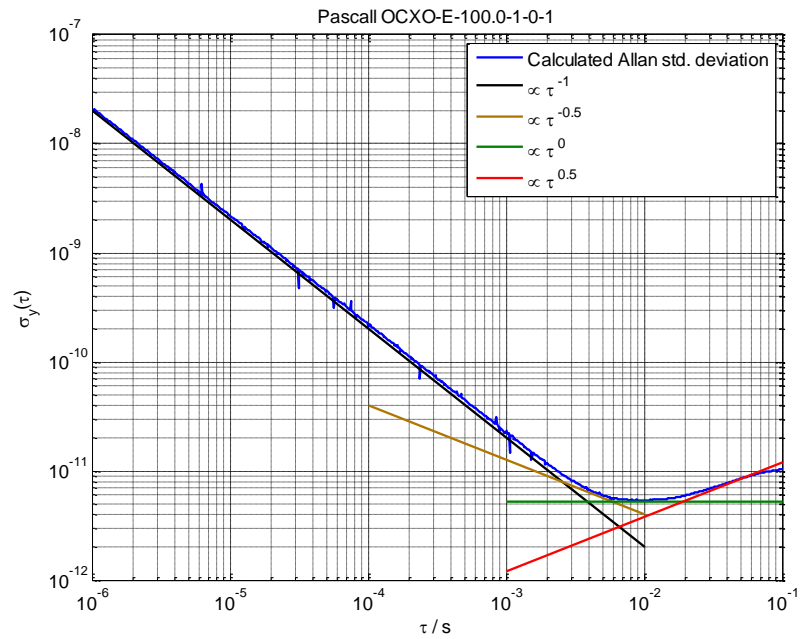

Figure 10 Allan std. dev. with marked up noise processes

## 8 Literature

1. Characterization of Frequency and Phase Noise, Report 580, International Radio Consultative Committee (C.C.I.R.), pp. 142-150, 1986.

2. Barnes, J. A., et al.; Characterization of frequency stability; IEEE Transactions on Instrumentation and Measurement; pp. 105-120; May 1971.
3. Chang, P. C., Peng, H. M., and Lin, S. Y.; Allan variance estimated by phase noise measurements; 36<sup>th</sup> Annual Precise Time and Time Interval Meeting; 2004.
4. Grebenkemper, C. J.; Local Oscillator Phase Noise and its effects on Receiver Performance; Watkins-Johnson Company Tech-notes; Nov./Dec. 1981.
5. Howe, D. A., Allan D. W., and Barnes J. A.; Properties of signal sources and measurement methods; Proceedings of the 35<sup>th</sup> Annual Symposium on Frequency Control; May 1981.
6. Makdissi, Alaa; <http://www.alamath.com/>, web site providing the AlaVar and other software
7. Rutman, J.; Comment on characterization of frequency stability; IEEE Transactions on Instrumentation and Measurement; p 85; Feb. 1972.

## 9 Additional Information

Please contact **TM-Applications@rsd.rohde-schwarz.com** for comments and further suggestions.

## 10 Ordering Information

### Spectrum / Signal Analyzer

|            |                |              |
|------------|----------------|--------------|
| R&S FSP40  | 9 kHz – 40 GHz | 1164.4391.40 |
| R&S FSV30  | 9 kHz – 30 GHz | 1307.9002.30 |
| R&S FSU67  | 20 Hz – 67 GHz | 1166.1660.67 |
| R&S FSUP26 | 5 MHz – 26 GHz | 1166.3505.27 |



# ROHDE & SCHWARZ

ROHDE & SCHWARZ GmbH & Co. KG · Mühldorfstraße 15 · D-81671 München · P.O. B 80 14 69 · D-81614 München ·  
Telephone +49 89 4129-0 · Fax +49 89 4129-13777 · Internet: <http://www.rohde-schwarz.com>

*This application note and the supplied programs may only be used subject to the conditions of use set forth in the download area of the Rohde & Schwarz website.*